

nodesign.net

Design with Vision. Vision by Design.

Extrême défi

Projet “L’Insolente”

1. Explorations

Véhicules essentiels

Willys Jeep, 1940

Equipement rudimentaire conçu en 3 mois



Biscooter Gabriel Voisin, 1950

- Dispose que de deux places
- Portes en option
- Carrosserie en aluminium.
- La référence en 1950 !
- A connu un gros développement en Espagne

Comment le refaire en 2022 ?



Piaggio vespa 400, 1957

Entre auto et quadricycle



Voiturette Motobecane, 1958



Mini Moke, British Motor Company, 1963

- Version militaire de la Mini
- Structure caisson
- Petites roues
- Banquettes arrière et toile de toit démontable



Citroen Mehari, 1968

- Design de Jean-Louis Barrault sur base Dyane Citroen.
- Carrosserie ABS Thermoformée
- En rabattant la banquette arrière (optionnelle), elle se transforme en une deux-places pour un usage utilitaire



F-City, Fam

Auto assimilable par les services techniques des villes



<https://www.automobile-propre.com/f-city-premiere-citadine-electrique-francaise-de-serie/>

Lotus seven

“Light is right” (Collin Chapman)



Mini moke Lazareth, 2017



La bagnole, 2022

« Moins de matière consommé c'est mieux !
Moins d'énergie c'est mieux !
Moins d'industrialisation c'est mieux !
Moins de poids c'est mieux ! »

- Plus pratique et polyvalente
- Plus de plaisir et sensations de conduite
- Plus de liberté
- Plus en osmose avec votre environnement
- Plus éco-responsable



L'affranchie, 2017

- Moteur électrique ou hybride, d'un châssis en acier, d'une « carrosserie » en textile technique.
- Châssis et motorisation sont expédiés en kit et s'assemblent localement à la main, donc sans installations complexes, en moins d'une heure.

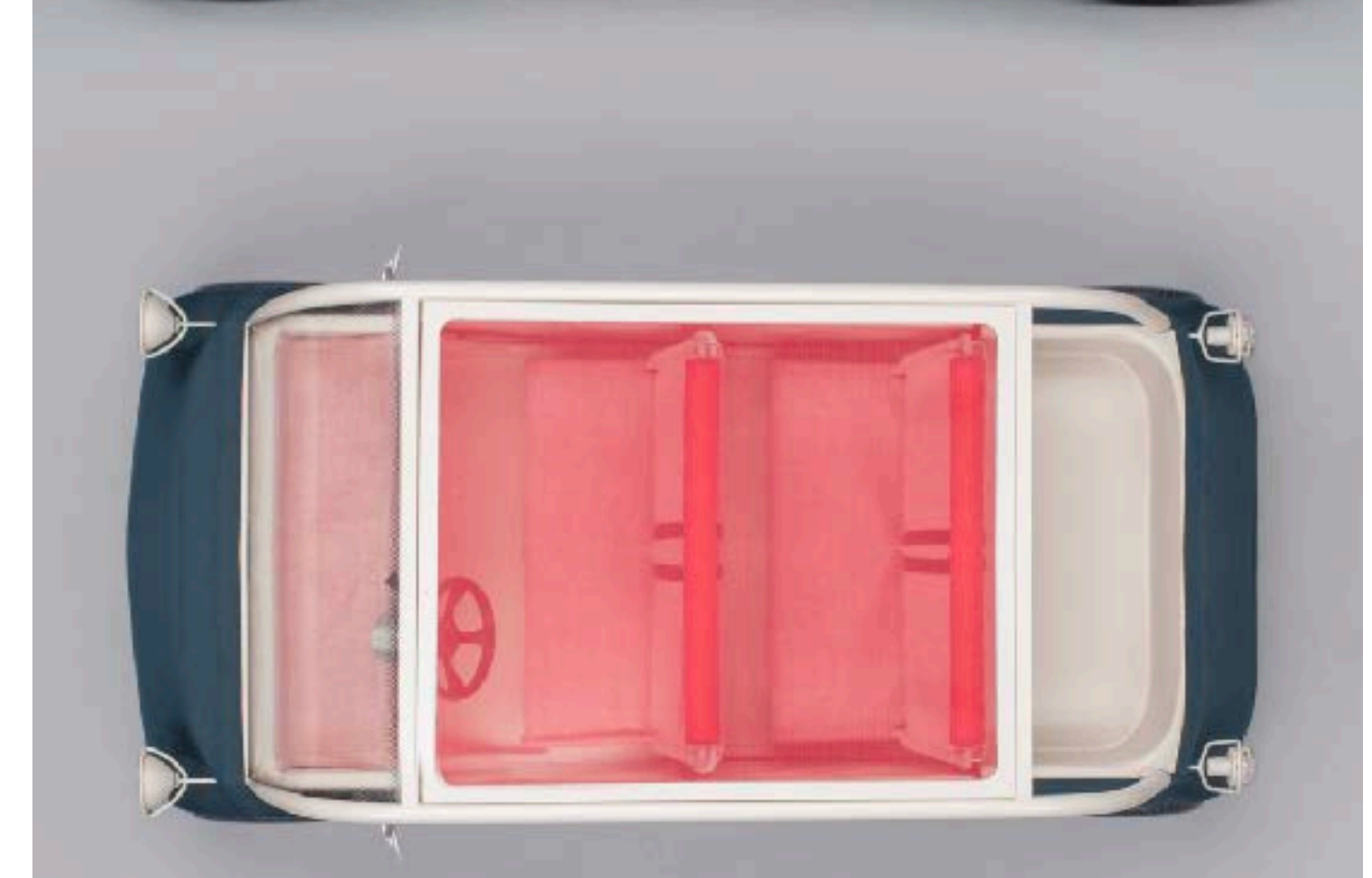
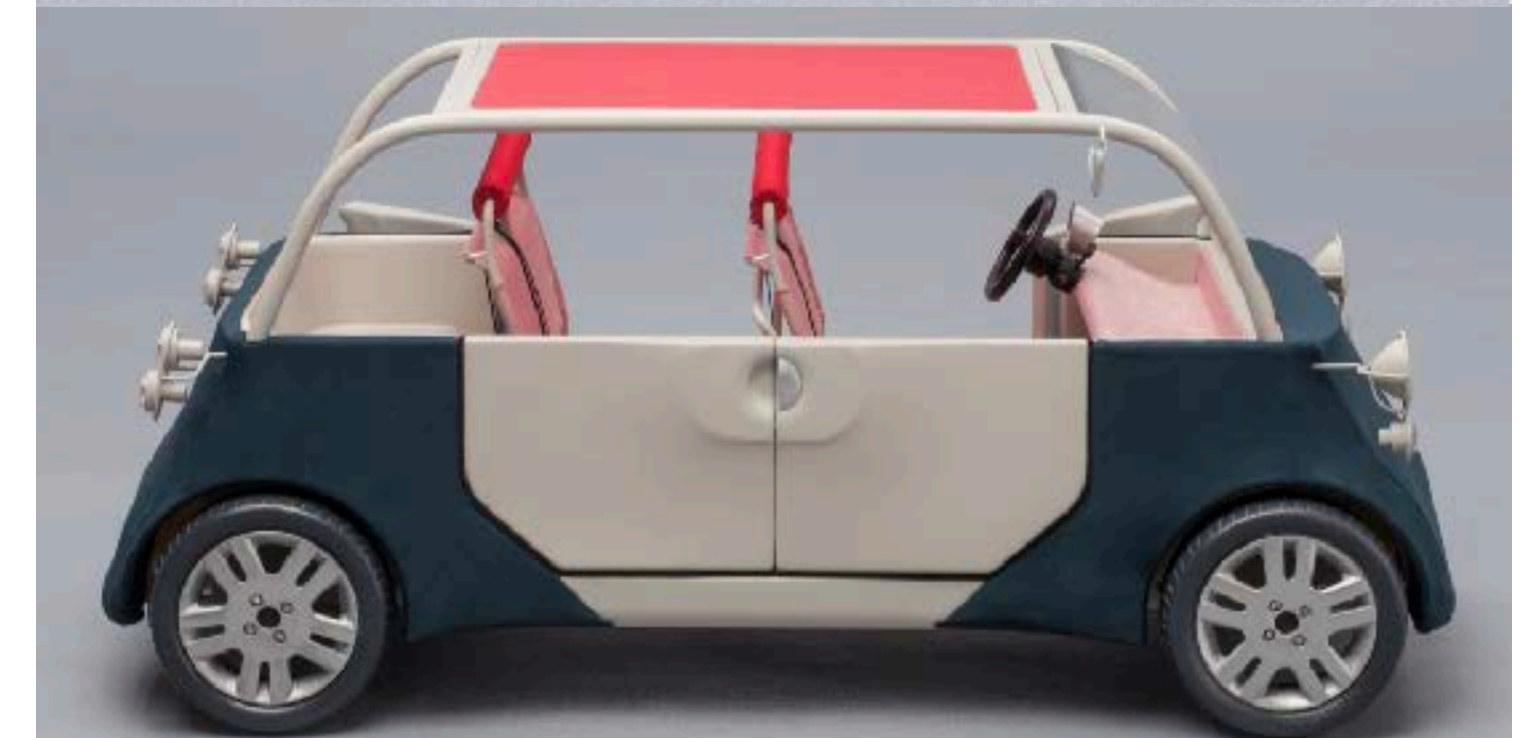

Auto à programme

EXE, Courreges Concept Car, 2004

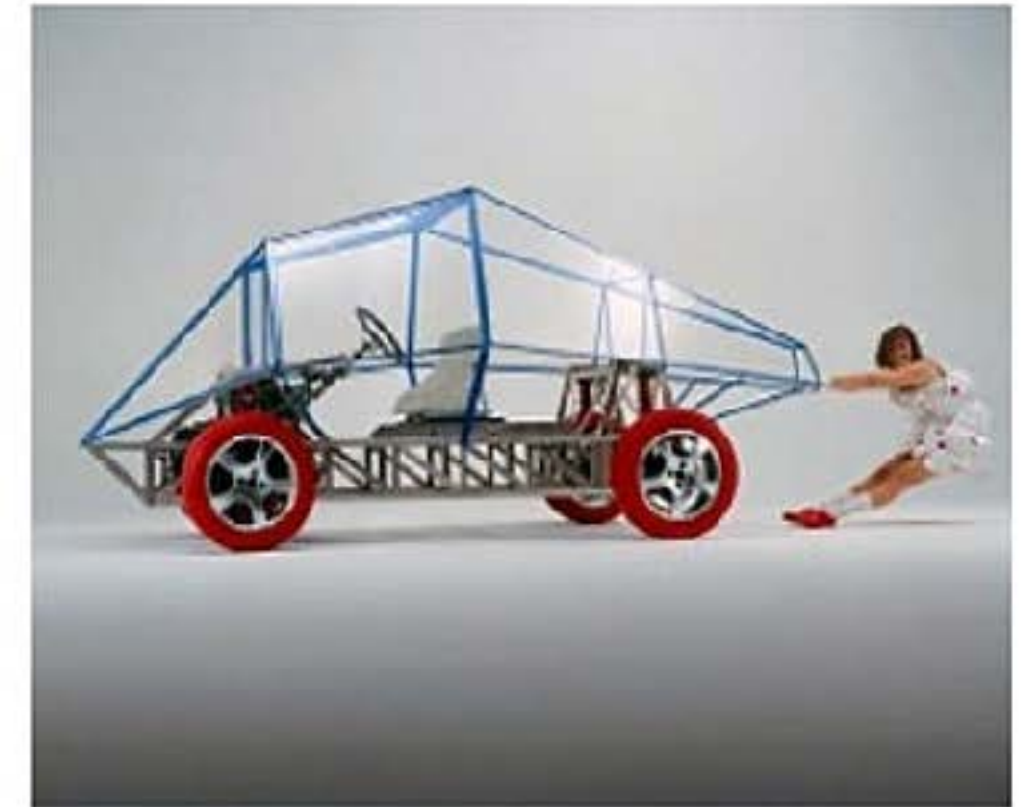
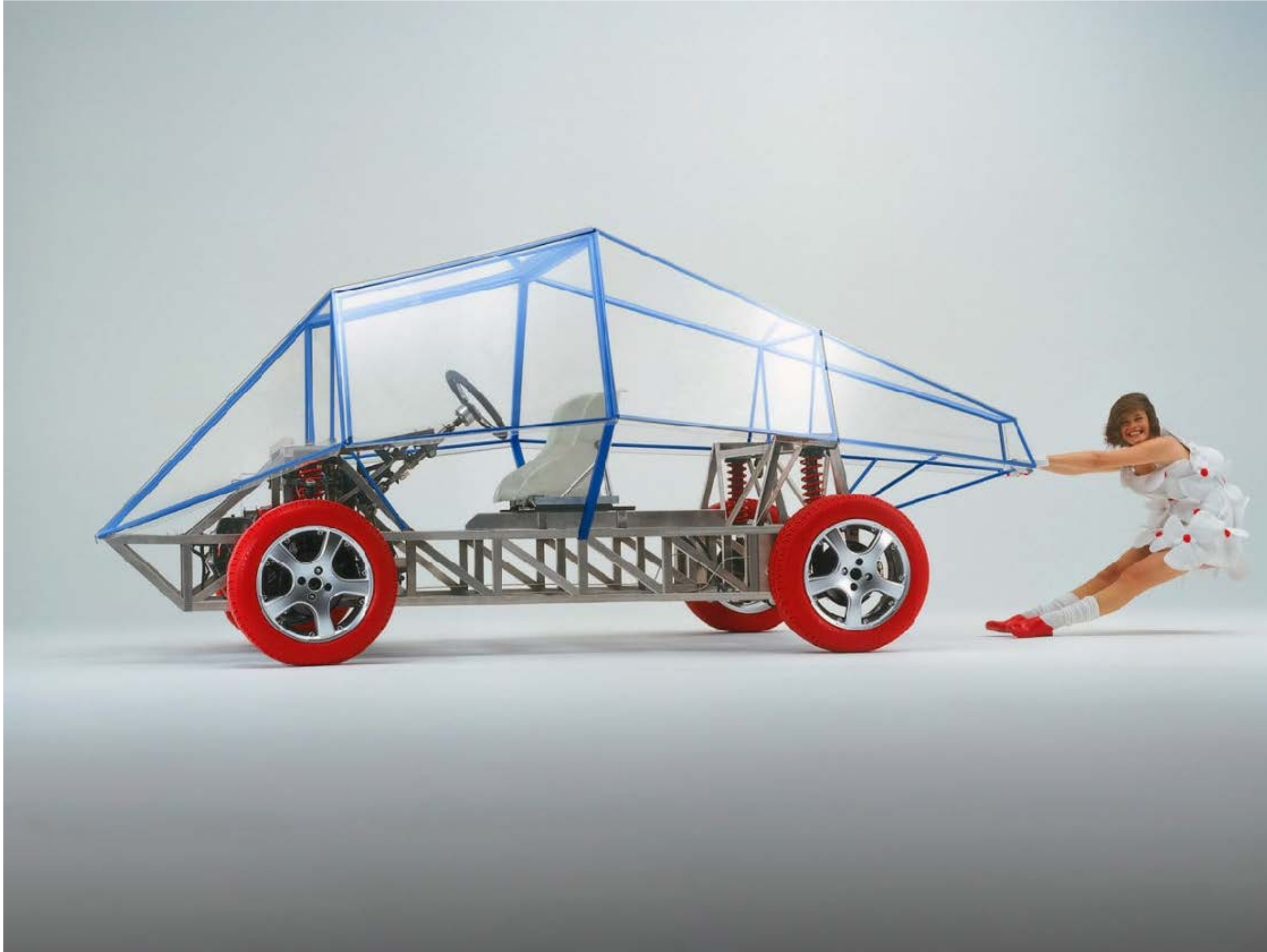

La bule, Courreges Concept Car, 2002



La zoop, Courreges Concept Car, 2006



Concept car Phoenix par Albrecht Birkner, 2014.



Zero 4 opensky sport, Tazzari ev



ZERO 4 OPENSKY TENDER



ZERO 4 OPENSKY LIMITED
nodesign.net

X bus E Bussy



Fiat Panda, 1980

Siège pliable et repliable

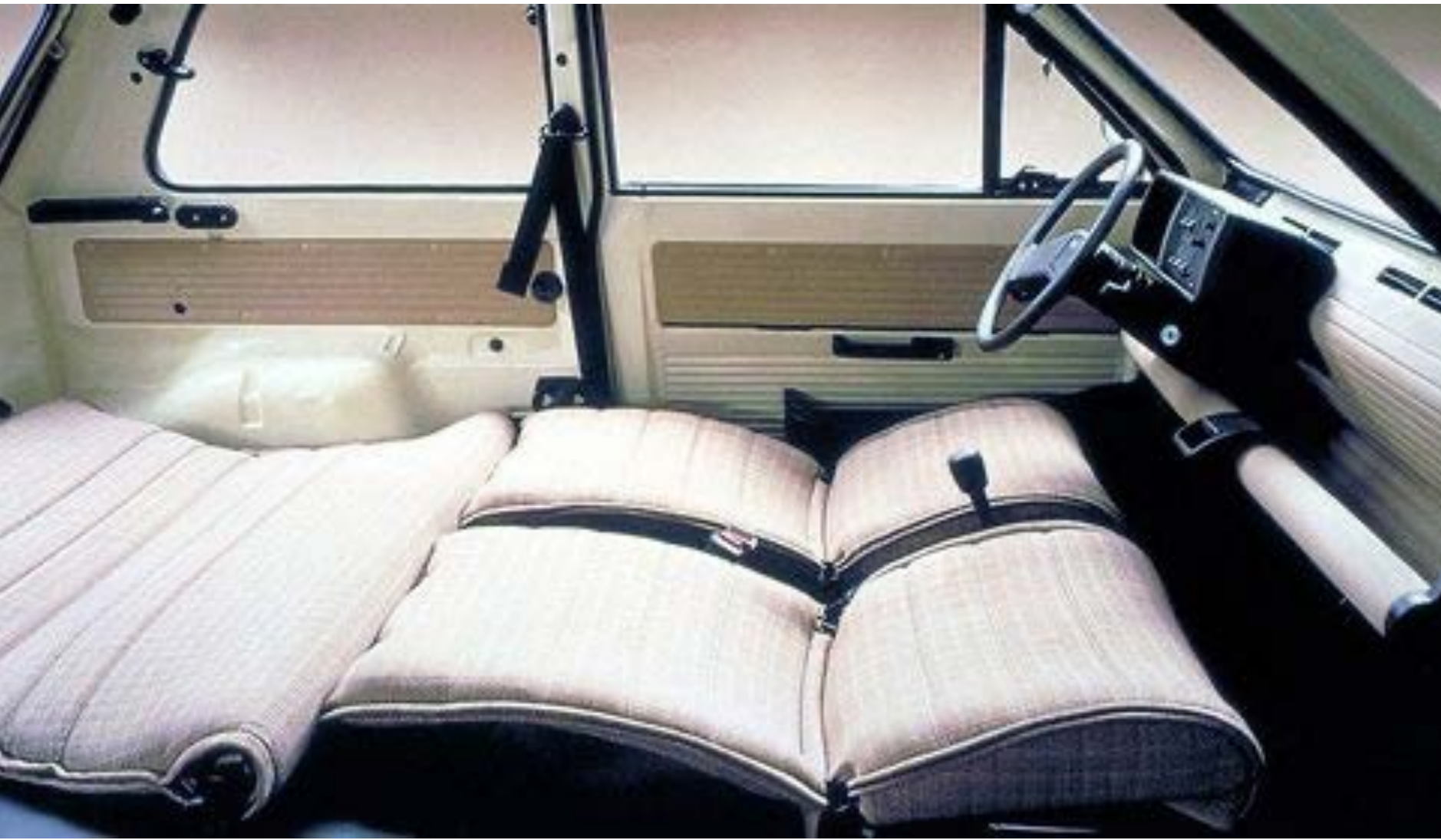

Ford 021c, Marc Newson, 1999



Formes sans couture et des surfaces trompeusement simples

Renault Twingo 1



Mia, 2011



Citroën Kar-a-Sutra, 1977

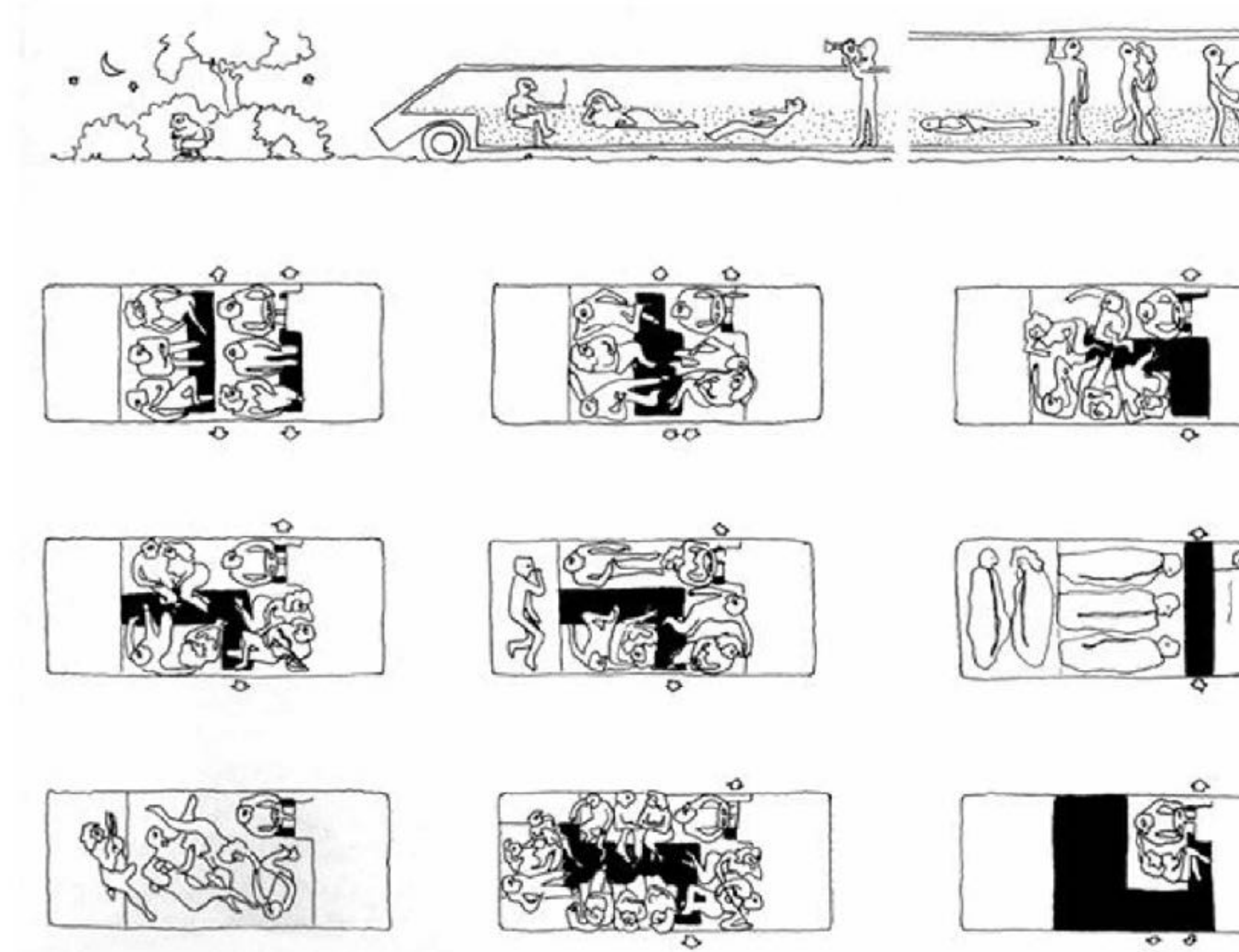

V+ (VOLTEIS) de Starck, 2012

Un véhicule tout simple, tout bête, comme dans les jeux d'enfants.



Sièges au cannage synthétique

Toyota ME-WE, 2014

Appuis têtes sont fixés directement sur le plafond du véhicule.



Tableau de bord connecté au téléphone



Réalisés en polypropylène expansé



Plancher se rapprochant de celui d'un parquet d'intérieur se prolongeant jusqu'à la console centrale

nodesign.net

Fiat Centoventi, 2019



Tableau de bord personnalisable



Citroën Ami, 2020

Petite voiture électrique sans permis.

Les portières s'ouvrent grand et la forme cubique offrent une sensation d'espace agréable.

Élément de sécurité absent à bord, pas d'airbag ni l'ABS ou l'ESP.



Citroën Ami, 2020

Smartphone connecté tableau de bord via une application



Siège pliable permettant un espace de rangement

Biogama, Manyone



nodesign.net

Dacia Manifesto, 2022



Dacia Manifesto, 2022



La facilité de



Plastique



Pneus sans



Le toit est versatile et multi-

Dacia Manifesto, 2022

Les housses des sièges sont amovibles et se transforment en sac de couchage.



Citroën Oli, 2022



Moto et scooter

BMW C1, 1999



Cake bike



MAKKA RANGE : WORK



MAKKA RANGE

Honda Ruckus



**Véhicule hybrides
(musculaire+électrique)**

Nimbus ev

Composants plus légers, prix faible et un véhicules plus sain pour l'environnement



CityQ

- Très proche d'un vélo
- Une place à l'avant et une l'arrière
- Roue, volant et tableau de bord intéressants



Bio-Hybrid

- Combinant les avantages d'un vélo et le confort d'une petite voiture.
- Proposé en utilitaire pour les livraisons du dernier kilomètre, se décline dans une version accueillant deux passagers en tandem.



Evan

- Cargo bike couvert
- Structure minimaliste
- Coffre vertical



Canyon Future Mobility Concept

- Compartiment passager totalement refermable et protégé
- Porte bagage limité
- Embarquement par le haut peu confortable

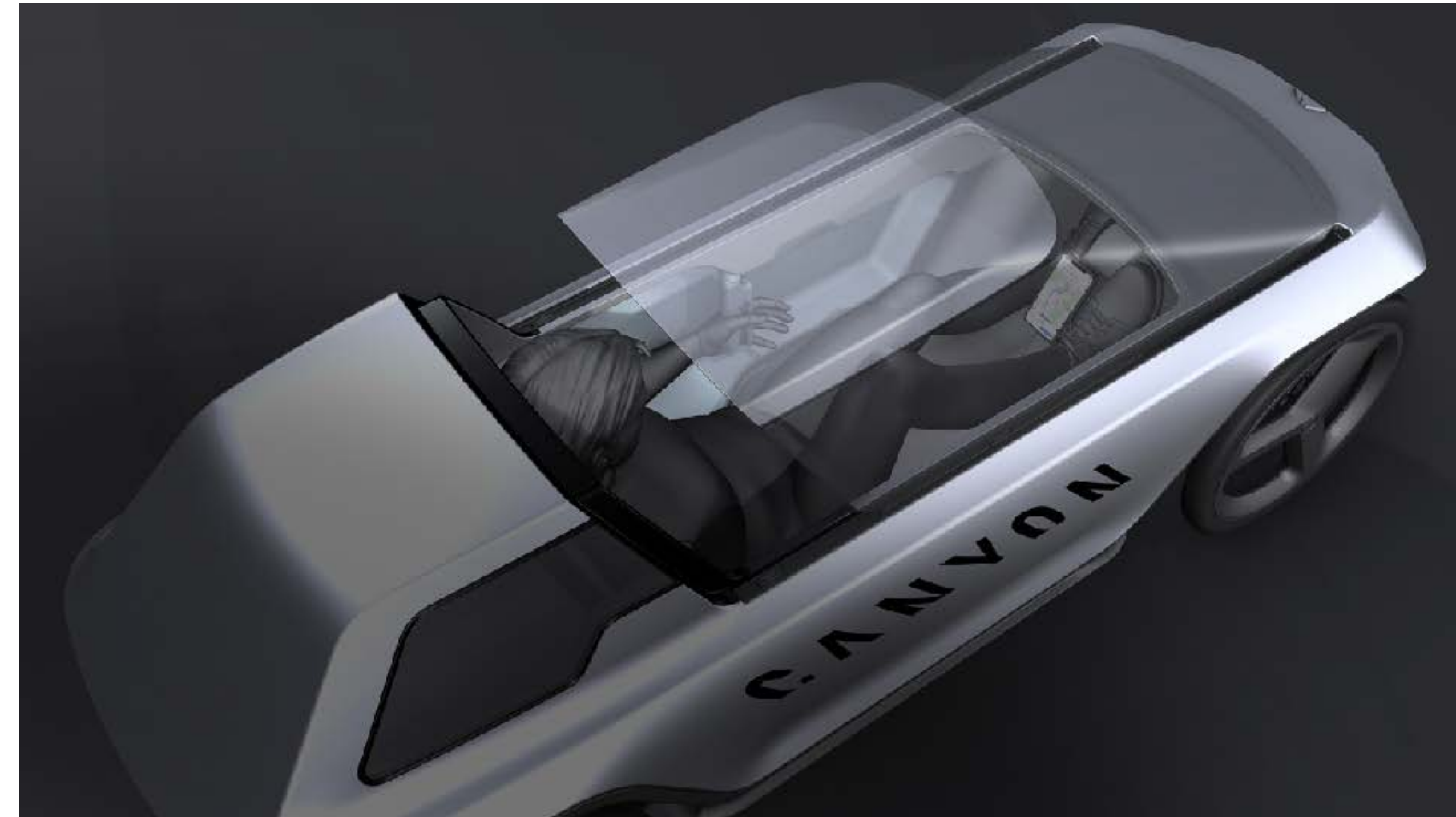

Midipile, 2017

- Carrossé- fermée
- Gamme d'équipement variés et modulables
- Matériaux recyclable



VERSION DUO

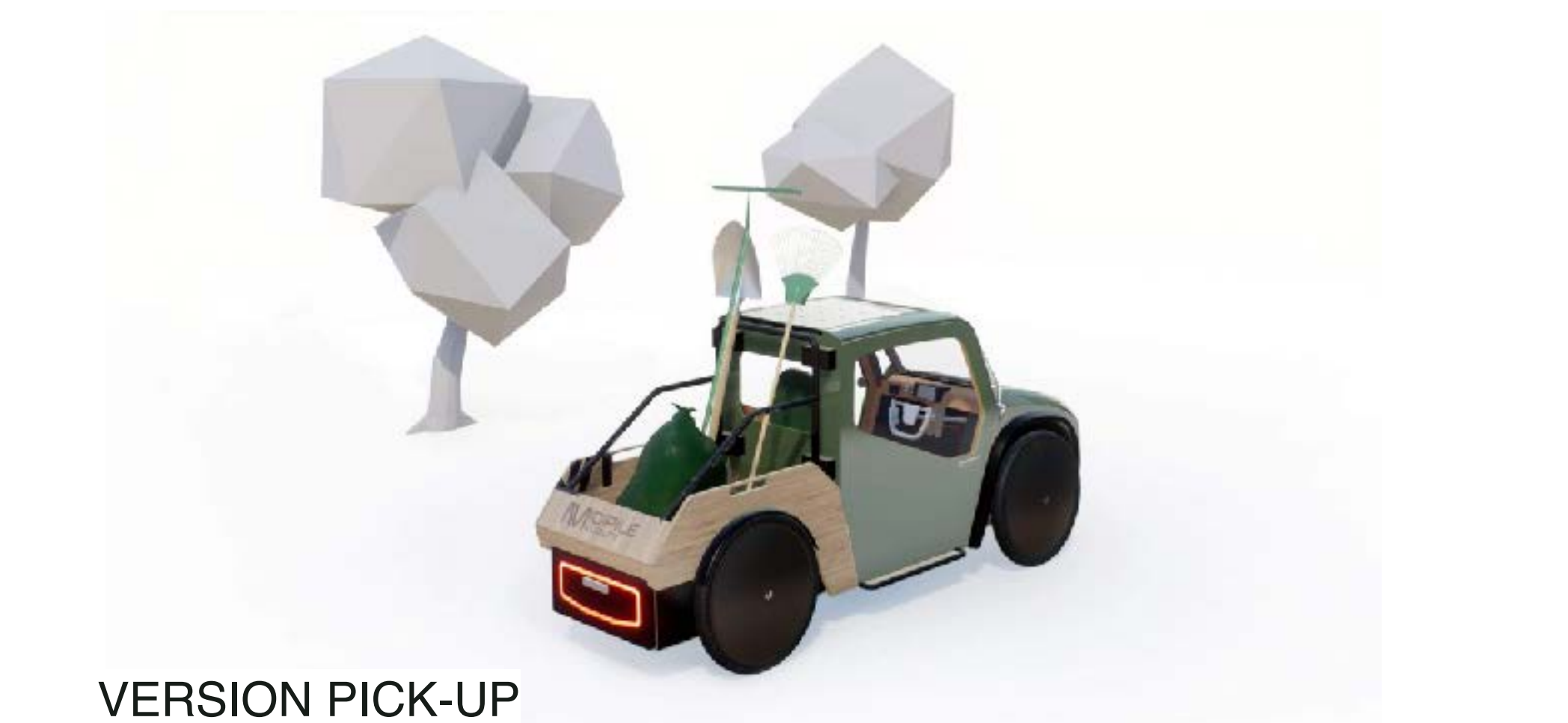

VERSION PICK-UP



VERSION CAISSE

Citlar

- Classé comme vélo mais avec les fonctionnalités d'une mini-fourgonnette
- Peut transporter jusqu'à 300 kilos



Véhicules compacts

Piaggio Ape 50,1947

- Plusieurs configurations
- Adapter au transport de marchandise
- Le véhicule préféré des paysans italiens



ISO Rivolta BMW Isetta, 1953



BMW Isetta 300, 1957



Microcars 1955



Microlino, 2021

- Voiture électrique idéal entre la moto et la voiture
- Comporte deux places



Renault twizy



nodesign.net

Gem



Mini truck de Ha Truong, 2017



Kart tout terrain

Can-am



nodesign.net

Street legal golf cars



Polaris général 1000 eps deluxe abs



Meyers Manx 2.0, 2022

Buggy



Pioneer 1000, Honda



Mises en œuvre, matériaux

Structure mécano-soudé en acier



Acier tubulaire Osborn Metals

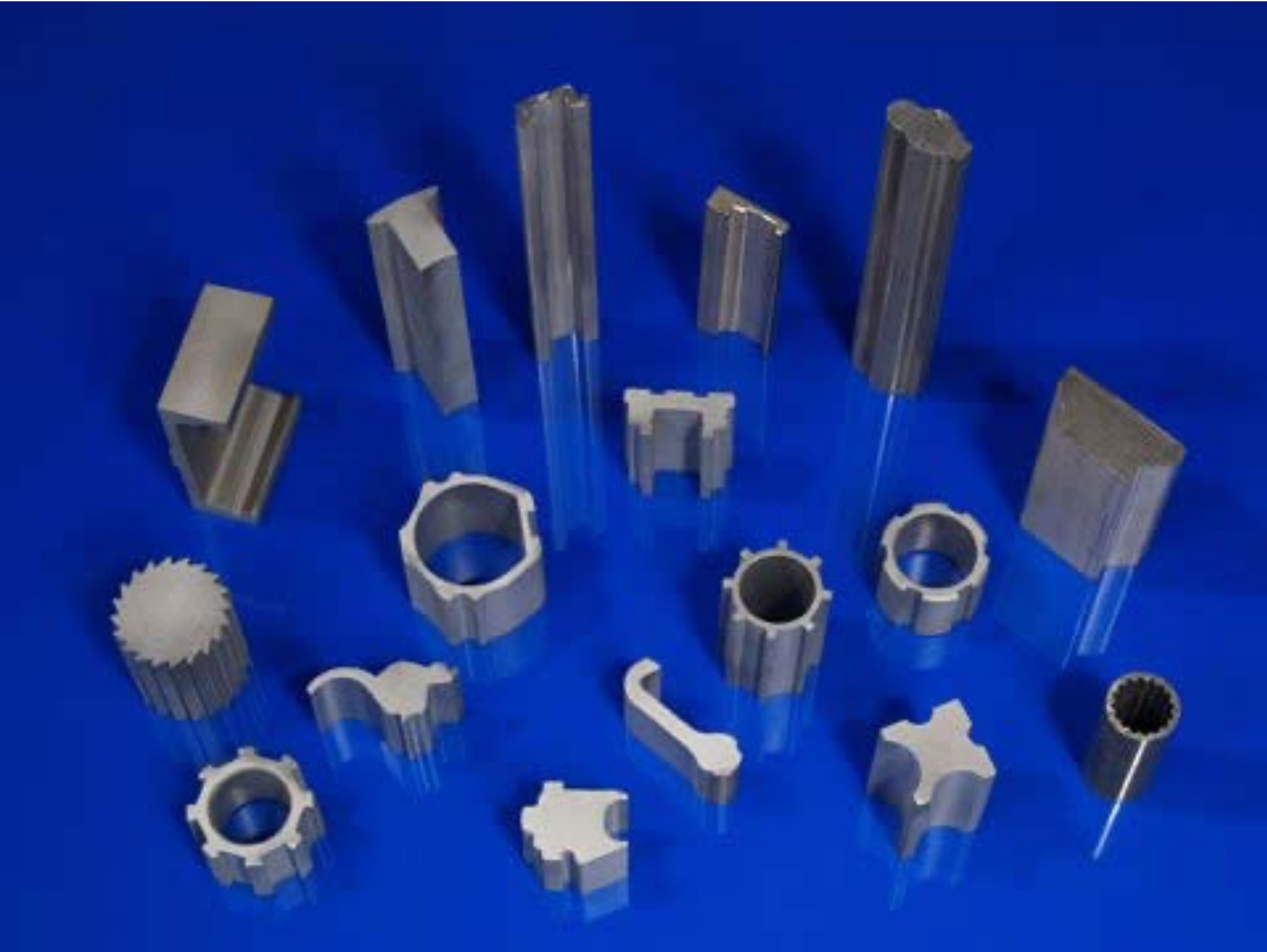

Matériaux composites

Conserve les propriétés mécaniques de l'acier tout en diminuant de 25 % le poids d'un assemblage.



Fibre de verre



Fibre de carbone



Fibre de lin

Matériaux légers et recyclage

ARKEMA

Résine Elium



Sert à réaliser des pièces composites thermoplastiques thermoformables et recyclables.

Kepstan



Acquiert une résistance accrue aux chocs violents, aux températures élevées et aux produits chimiques très agressifs.

Liège



Mazda

Chute des Voiles voiliers de compétition

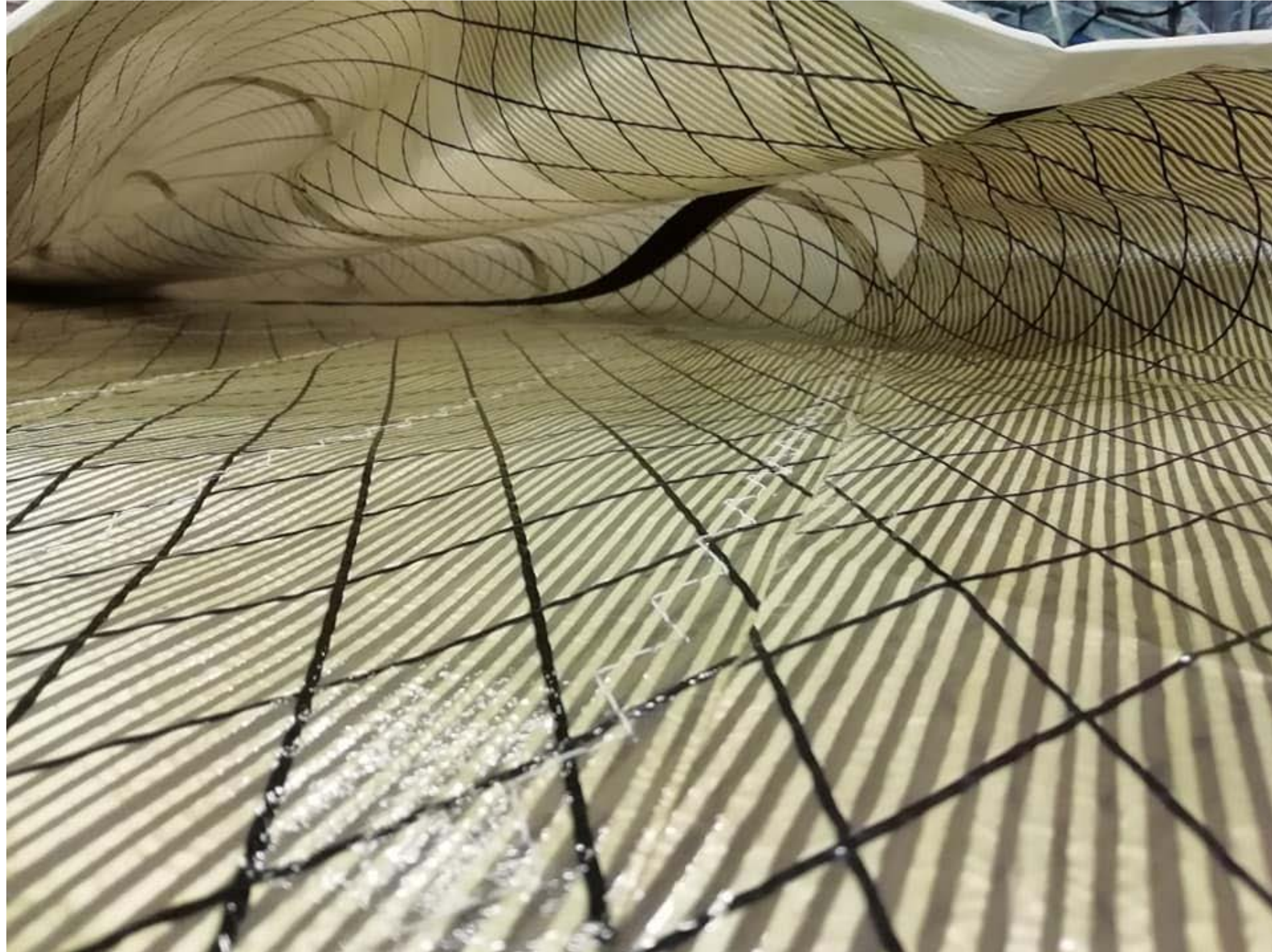

Écran de bord

Head up and display



Projecteur pour téléphone

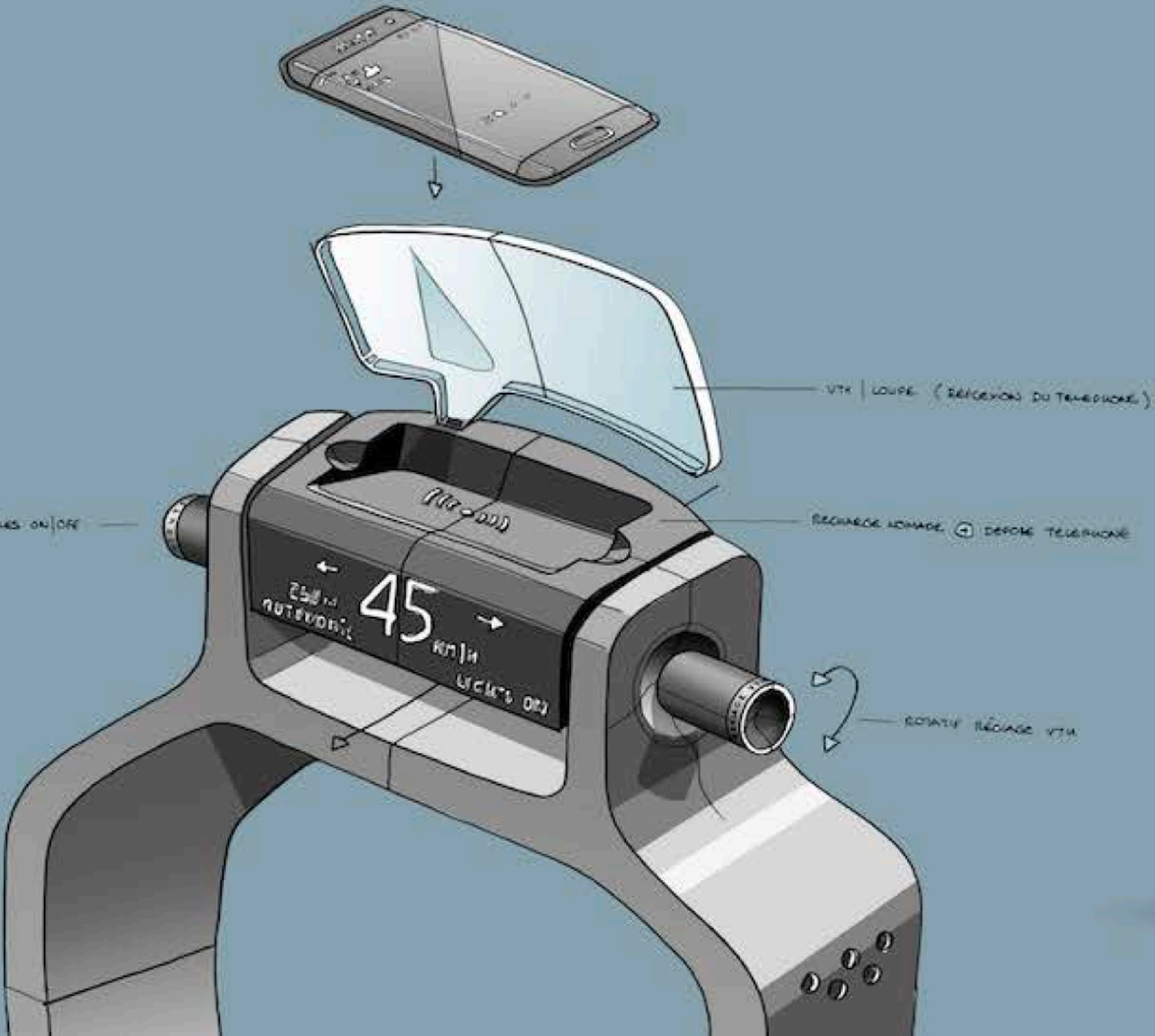

Toute l'intelligence connectée dans le téléphone



Tous les éléments dédiés à la conduite

Loupe pour téléphone

Esquisse idée NoDesign



Pneus

Pneus 24 pouces



Roue pour Pocket cross

Taille de pneu : 12 ½ x 2;75

Entre axe de disque et couronne : 34mm

Axe de roue : 10mm



Univers et imaginaires

Earth Roamer XV-JP



Shelter, Tradewinds



nodesign.net

Caravane papillon, Eduard Böhntlingk



Wagon, Tradewinds

